

Article number: 057153302502

Description: HEPCO GV3 bearing BHJ 25 E
Standard for Blind hole Fixing

Measures

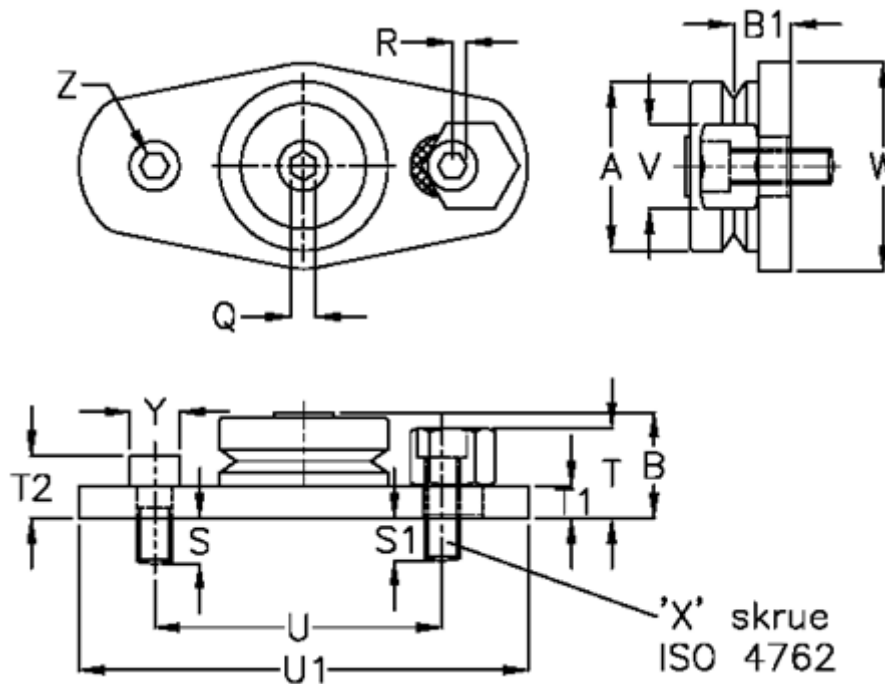

a = 25.0	T1 = 5.00	Y = 8.5
B = 16.6	T2 = 10.00	Z = 10
B1 = 9.00	U = 50.0	
Q = 3.0	U1 = 72.0	
R = 1.5	V = 14	
S = 7.00	W = 32.0	
S1 = 9.0	Weight kg/1000 = 0	
T = 12.0	X = M5	